

ThermoSphere Ultimate®

The first electric heating cable with guaranteed reliability



Contents

3	Thermosphere Ultimate features
4	Product checklist
8	Preparation
10	Pre-installation testing
13	Installing membrane
15	Installing heating cable
17	What not to do
18	Post installation testing
20	Installing the floor sensors
21	Post installation sensor testing
22	Tiling over membrane
24	Final testing
27	Wiring your underfloor heating thermostat
29	Commissioning your underfloor heating
30	Test results record and customer handover
31	Warranty terms and conditions

Watch the installation videos!

Heating cable



Thermostat



ThermoSphere Ultimate® features



Cold tail (power lead)

ThermoSphere Ultimate® Heating Cables feature a slim, in-line hot/cold joint.

This means the cable will be yellow up at the thermostat wiring point, as well as under the floor.

Identify the cold tail

The cold section of cable is marked **COLD** along its entire length.

The **COLD** section of the cable does not get hot, so can be run up the wall, within a conduit, to the thermostat wiring point.

Floor/wall junction

The **HOT** section of cable must not begin closer than 100mm to the wall.

All of the **HOT** section of cable must be situated within the floor and must not be inserted into the wall, the conduit or positioned under permanent fixtures or furniture.

Hot/Cold junction

The join between the **HOT** and **COLD** sections of the cable is shown by **BLUE/RED** marker and a **HOT/COLD** label.

The markers and label must both be fully encased in the floor, embedded in flexible tile adhesive or levelling compound.

Product Checklist



ThermoSphere Ultimate®

Designed for seamless installation into ThermoSphere Membrane.

ThermoSphere Ultimate combines in-line joint technology with TwistedTwin cable construction to provide the most robust heating cable that's fast and easy to install.

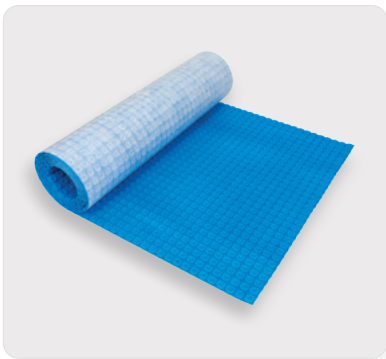

ThermoSphere Membrane

ThermoSphere Membrane is a patented polypropylene membrane with rounded square shaped studs that form channels specifically designed to hold ThermoSphere Ultimate Heating Cables.

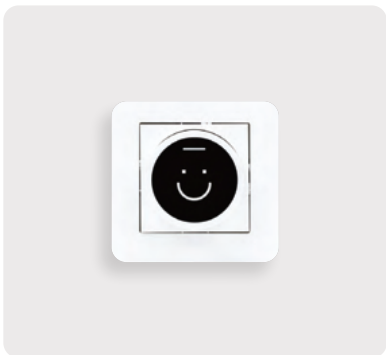

ThermoSphere Controls

ThermoSphere Ultimate is compatible with our complete thermostat range.

Model shown in this guide is the BT21 Bluetooth Programmable Thermostat.



Floor Sensor Probe

Found within your BT21 thermostat box are your Floor Sensor Probes (second sensor sold separately with other thermostats). They are an essential part to your installation to ensure your thermostat knows when your floor needs heat and when it doesn't.



Perimeter Insulation Foam

This 8mm thick edge insulation strip should be installed around the perimeter of the room to act as a cushion for the slight expansion/contraction your floor will experience during heating and cooling.

The foam also acts as a thermal barrier around the edge of the floor, reducing heat loss into the walls.



Timber and Concrete Insulation Boards

ThermoSphere insulation boards provide a thermally insulated, prepared surface for the installation of electric underfloor heating systems.

Insulation boards should be installed directly below the heating system to increase efficiency and reduce running costs.



Tile Adhesive

Used to adhere fleece backed Membrane to the sub-floor. Use a trowel to spread in metre square sections to ensure the adhesive doesn't dry before laying your Membrane.



Self-levelling Compound

An optional step in your Membrane installation. Used to smooth and level floors in preparation for laying tiles, and to encapsulate heating cables.



Flexible Conduit

Protect your underfloor heating cold tail and temperature sensors from damage, impact or moisture and ensure you can replace the floor sensors if required.



Fibreglass Mesh Tape

Use along the seams of Insulation Boards to reinforce the joints.



Fixing Screws and Metal Washers

Use these to secure Timber Insulation Boards to timber sub-floors.



Electrical Back Box

Required for installing a thermostat onto a cavity wall.

Substrate preparation

Preparing the substrate is the vital first step in any underfloor heating installation. Before you start the sub-floor must be clean, stable and ready for tiling. Be sure to follow the correct steps for your substrate!

Timber Substrates

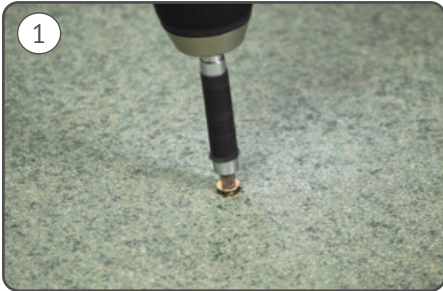

1 Make sure that the sub floor is level, stable and that there is no vertical bounce/deflection.



2 Fix perimeter foam around the edge of the room using the self-adhesive strip or staples.

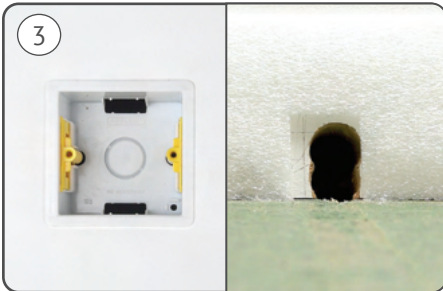

3 Install a back box for your thermostat and drill a 20mm hole below at the floor/wall junction.



4 Ensure the timber substrate is clean and free from any dust and debris.

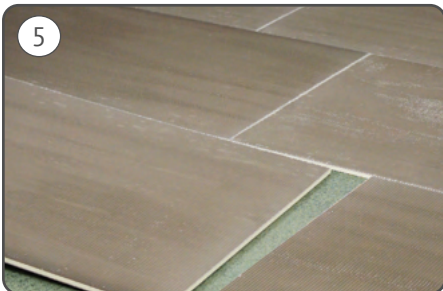

5 Lay timber insulation boards in a staggered brickwork pattern, over the whole floor. Use a sharp blade to cut the boards to fit around the perimeter.

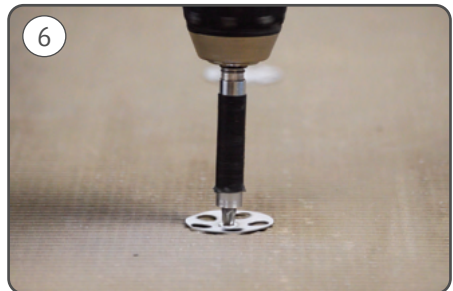

6 Fix the insulation boards to the substrate with screws and washers spaced evenly at 300mm centres around the board, and in the centre.

Tip!

We recommend using our fibreglass mesh Joint Tape along the seams to reinforce the board joints and create a flat base before tiling.

Concrete substrates



Fix perimeter foam around the edge of the room using the self-adhesive strip or staples.

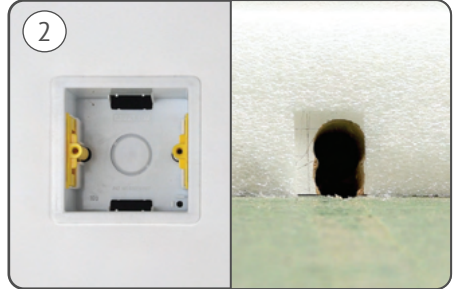

Install a back box for your thermostat and drill a 20mm hole below at the floor/wall junction.



Ensure the substrate is clean and free from any dust and debris



Mix tile adhesive and comb in straight lines over the substrate, enough for one board at a time.



Lay the insulation board in a staggered brickwork pattern over the floor. Press firmly to push any air out and ensure good adhesion.

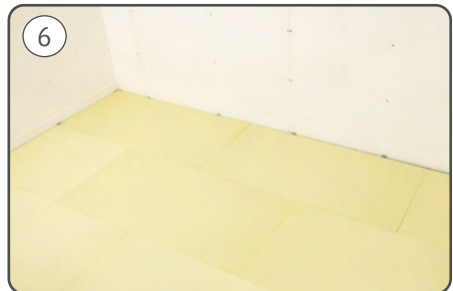

Use a knife to cut the boards to size and ensure the whole floor is covered.

Pre-installation testing

ThermoSphere Ultimate® cables must be properly tested before and after installing, as well as once the floor finish has been applied. This ensures no damage has been done prior, to or during your installation.

Heating cable resistance test



Remove your heating cable from the box and take off the card protection sleeve.



Turn your test meter on and set to Ohms (Ω).



Connect one of the clips to the Neutral (Blue) wire.

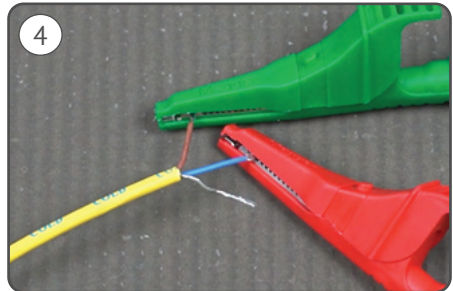

Connect the second clip to the Live (Brown) wire.



Check the meter reading is within -5 to +10% of the manufacturer's value on the labels.



Note the part number and resistance reading in the table on page 30 of this guide.



All electrical testing and connections should be done by a skilled, professional electrician.

Heating cable insulation resistance test



Set your test meter to $M\Omega$ at 500V. This will test the insulation between the cable cores.

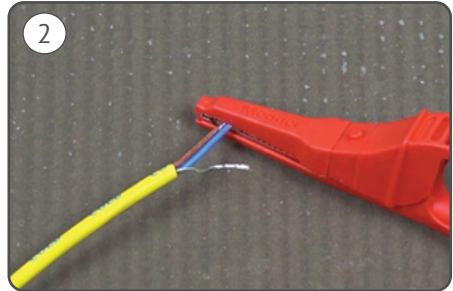

Connect one of the clips to the Live (Brown) and Neutral (Blue) wires.

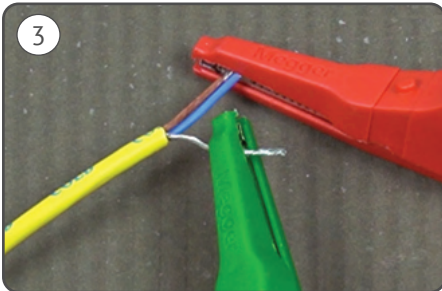

Connect the earth wire to the second clip.



Press test on the meter. Readings over 499 $M\Omega$ are considered a pass. (Reading range may differ depending on the meter used).



Note the insulation resistance reading in the table on page 30 of this guide.



All electrical testing and connections should be done by a skilled, professional electrician.

Floor Sensor resistance test



Remove both of the floor sensors from your thermostat box.



Set your test meter to Ohms.



Connect the cables to the terminals. There is no polarity, so it doesn't matter how you do this.



The resistance value should be close to the value in the table below, for the ambient temperature.



Note the resistance reading in the table on page 30 of this guide.

Temperature °C	Resistance kΩ
0°C	32
5°C	25
10°C	20
15°C	16
20°C	12
25°C	10
30°C	8

(Floor Sensor resistance values table)

Installing membrane

Now it's time to install your membrane. Follow the correct steps depending on whether you've opted for fleece-backed or self-adhesive Membrane.

Fleece-backed membrane

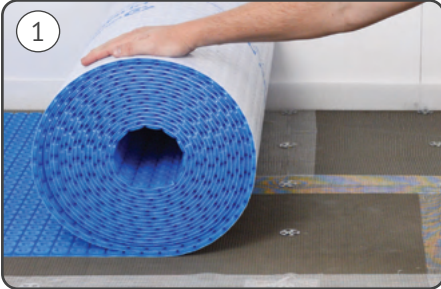

Start in one corner of the room and roll out the membrane over the floor.



When you reach an obstacle or the end of the room, cut the membrane with a sharp blade.



Move the membrane and comb tile adhesive over the floor in straight lines ensuring full coverage.

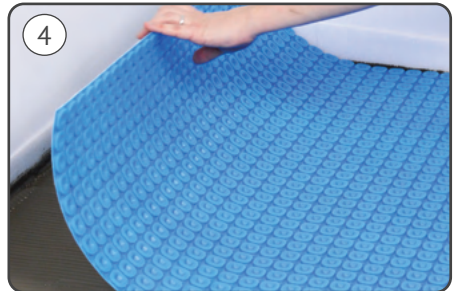

Lay the membrane and press down with even pressure to ensure full adhesive coverage.



Peel back a small section of the membrane to check the back is fully covered in adhesive.

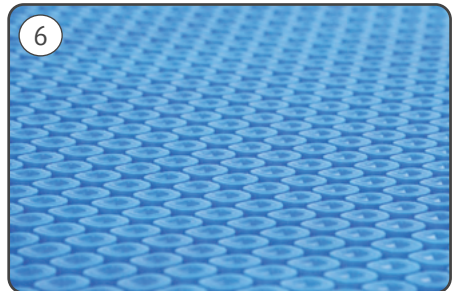

Repeat this process until your floor is covered. Make sure the dimples align from strip to strip so the cable can be installed in straight runs.

Self-adhesive membrane

Self-adhesive membrane is designed only for installation on new, clean, dry plywood or chipboard sub floors.

Make sure to lay out and cut to size before sticking down!



Begin by peeling a small section of the protective film off the back of the Membrane.

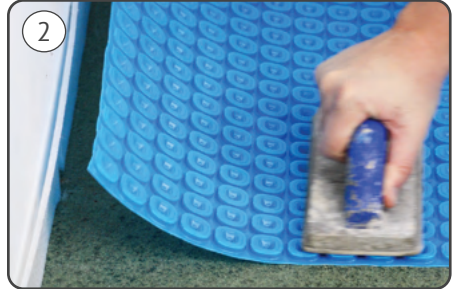

Firmly press this area of the Membrane onto the substrate using a float or weighted roller.

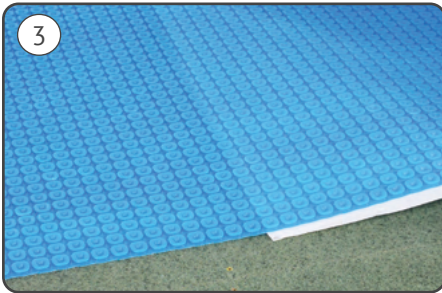

Peel off the rest of the film and firmly press the Membrane into the sub floor.

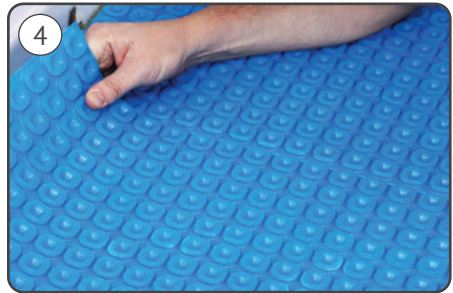

Align the dimples of the next piece of Membrane, peel off the film and secure in place.

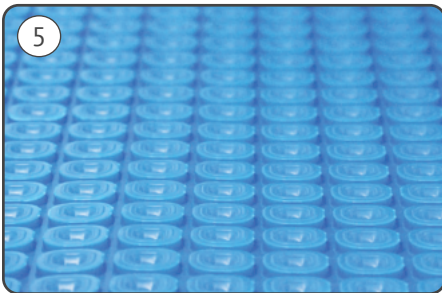

Repeat this process until your floor is covered. Use a weighted roller to ensure good adhesion.



Make sure you mark out any unheated areas so you don't put heating cable where it's not needed or may be covered by furniture.

Top tips for installing the heating cable

Now your membrane is laid, it's time to install your heating cable making sure that only the **COLD** section is run up the wall to the wiring point.

Here are our top tips to making your installation as easy as possible.



Feed the cold tail through the hole at the base of the wall and up to the back box.

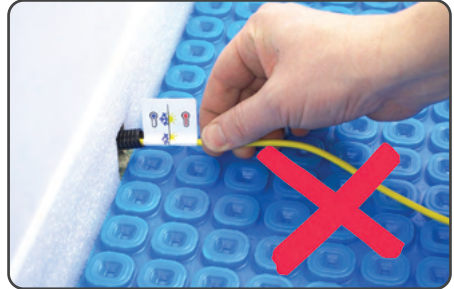

WARNING! Don't feed the heating part of the cable into the wall.

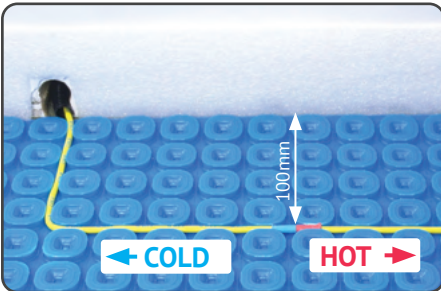

Make sure the heating part of the cable starts 100mm away from the edge of the wall.

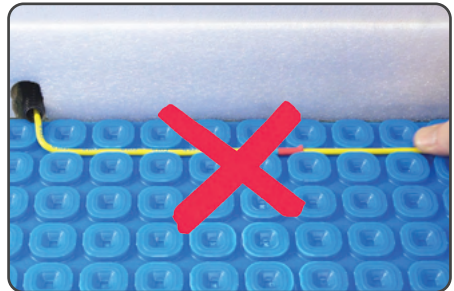

WARNING! Do not install the heating part of the cable within 100mm of the wall.

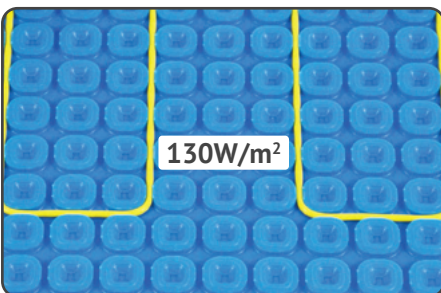

Use spacing of 3 dimples for a 130w/m² output.

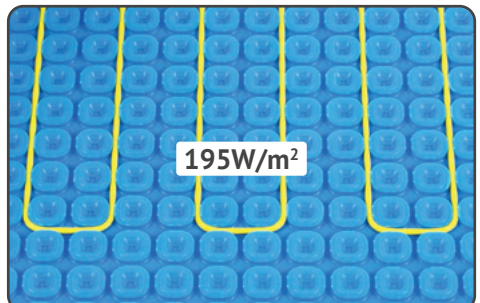

Use spacing of 2 dimples for a 195w/m² output.



For ease, use a float or a roller to help push the cable into the mat.

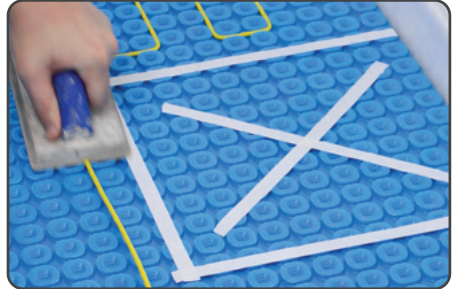

Note: Remember to avoid installing heating cable in unheated areas of your room.



Keep an eye out for the halfway there label. You're halfway through the cable!

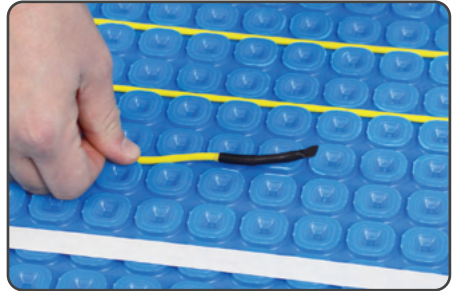

When you reach the end termination, press it into the Membrane. Make sure all heating cable is securely pushed into the mat.

What not to do with your membrane and heating cable

Make sure you understand what not to do with your Membrane and heating cable so that you can avoid common mistakes in your installation.

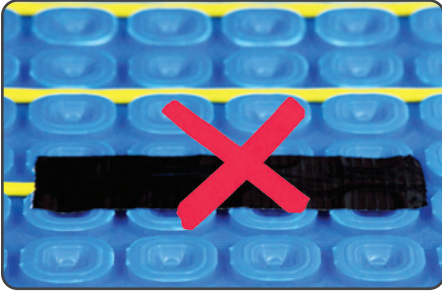

Don't use fixing tape over any part of the cable. This causes overheating and cable failure.

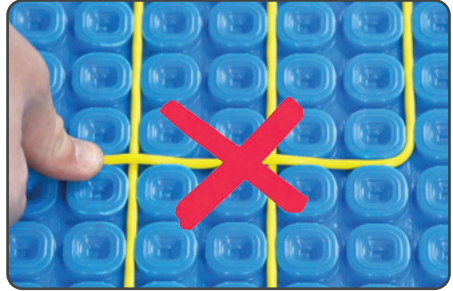

Don't overlap or cross your heating cable.

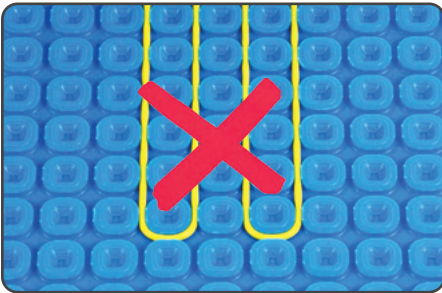

Only use 3 or 2 dimple spacing. Incorrect spacing leads to overheating and floor damage.



Don't cut the heated part of the cable!

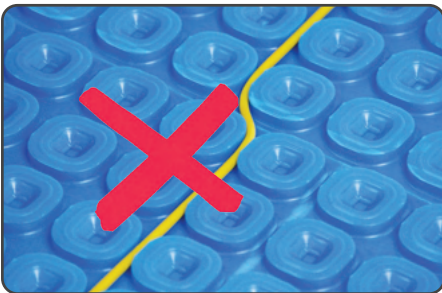

Don't misalign the Membrane dimples, as your cable won't be able to run straight.

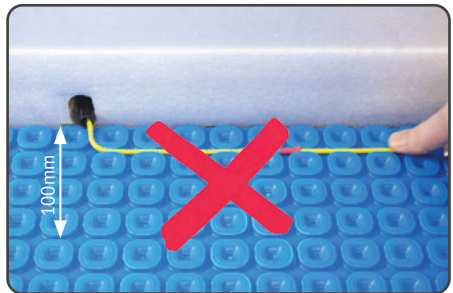

The cable must not be installed closer than 100mm to walls and unheated areas.

Post installation testing

To make sure there's been no damage during installation, you need to repeat the resistance and insulation resistance tests for your heating cable.

Heating cable resistance test



Get your test meter, turn it on and set to ohms.

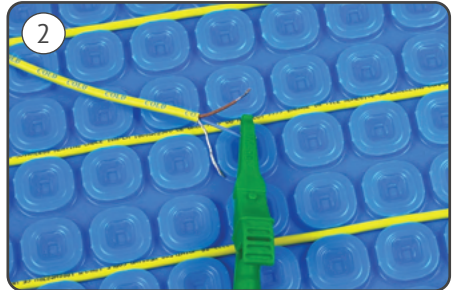

Connect the neutral (blue) wire to one clip.



Connect the live (brown) wire to the other clip.



Check your meter reading, it should be within +10/-5% tolerance of the values found on the product labels.



Note the readings in the customer handover document for their warranty registration.



All electrical testing and connections should be done by a skilled, professional electrician.

Heating cable insulation resistance test



1 Get your meter ready to test the cable insulation and set it to 500V.

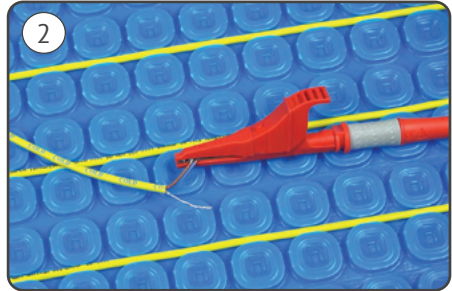

2 Connect the neutral (blue) and live (brown) wires to one clip.

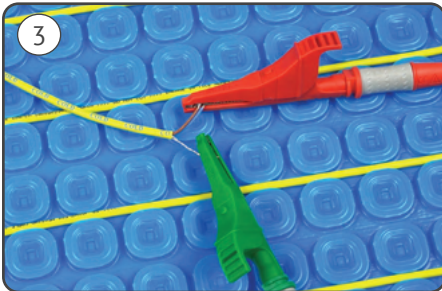

3 Connect the earth wire to the other clip.



4 Press test on the meter. Readings over 499 MΩ are considered a pass. (Reading range may differ depending on the meter used).



5 Note the results in the customer handover document for their warranty registration.

Watch the



installation video!

Installing the Floor sensor

Having a floor sensor ensures that you can monitor and limit the floor temperature. We always recommend installing the additional spare sensor found in your BT21 thermostat box, or supplied separately.

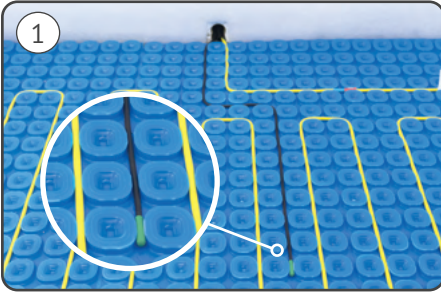

For 2 dimple heating cable spacing, install your floor sensor between 2 cables.



Note: Don't position your sensor near or under heating cable.

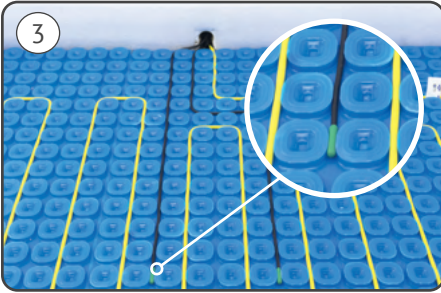

Install a spare floor sensor in the same way but position it away from the first sensor.

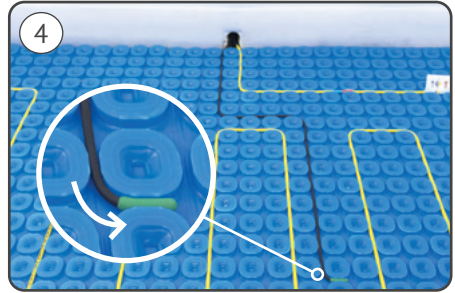

For 3 dimple spacing, you'll need to turn your cable into the middle of the dimples.

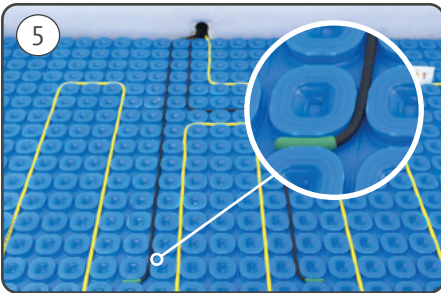

Install a spare floor sensor in the same way but position away from the first sensor.

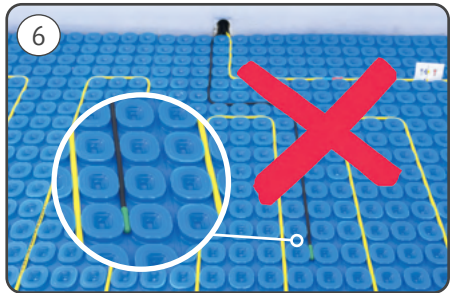

Note: for 3 dimple spacing, the sensor must sit in the middle of the cables, not as above.

Post installation sensor testing

Floor sensor resistance test

To make sure there's been no damage during installation, you need to repeat the resistance test for your floor sensors, including the spare!



All electrical testing and connections should be done by a skilled, professional electrician.



Set your test meter to ohms.

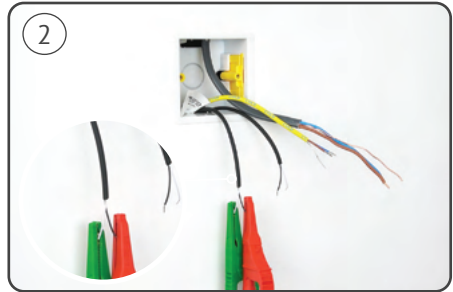

Connect one cable to each clip. The cables have no polarity.



The resistance value should be close to the value in the table below.

Temperature °C	Resistance kΩ
0°C	32
5°C	25
10°C	20
15°C	16
20°C	12
25°C	10
30°C	8

(Floor sensor resistance values table)



Record the results of the floor sensor.

Tiling over Membrane

You can tile directly over Membrane or use self levelling compound before tiling. Either step is essential as it provides a heat sink for the heating cable.

Tiling directly over Membrane

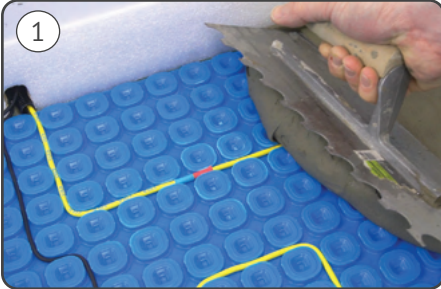

Mix your tile adhesive and carefully trowel over the cold tail joint and work into the Membrane.



Use the flat side of the trowel to push adhesive into the grooves to ensure no air gaps.



Make sure the floor sensor ends are completely covered in adhesive.

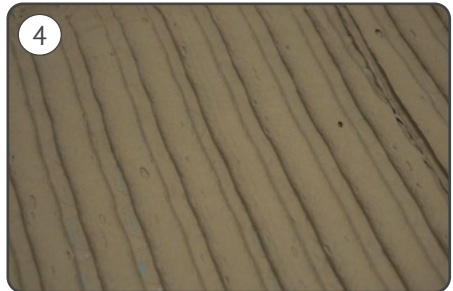

Cover the rest of the heating cable in adhesive and comb over using a notched trowel.

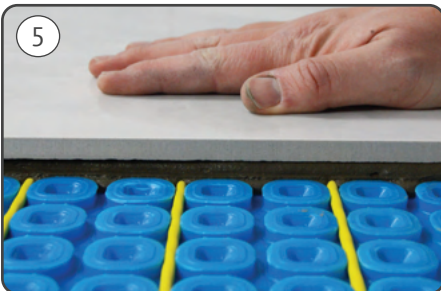

Ensure the cable is covered with a full bed of tile adhesive that is at least 5mm thick.



Fix tiles over the rest of the floor. For best results back butter your tiles.

To ensure a flat, smooth surface you may decide to use self-levelling compound before tiling. This is an optional step that covers the heating cable well.

Levelling compound before tiling

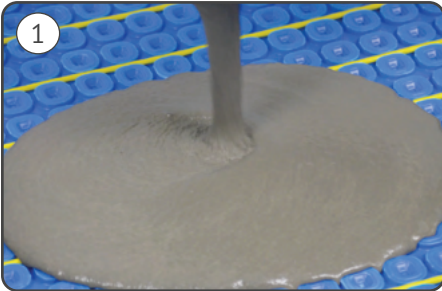

1 Mix self levelling compound according to instructions and pour over the floor, ensure the cable is covered.

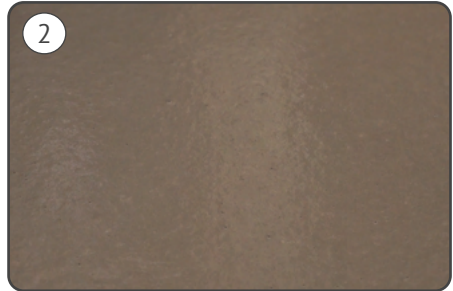

2 Ensure the entire cable is covered, including the hot/cold junction, the hot cable and end termination.



3 When levelling compound is ready for tiling, spread tile adhesive over using a notched trowel.



4 Back butter and lay the tiles over the floor.



Electric underfloor heating must not be switched on until all tile adhesives and levelling compound layers have fully cured. Check instructions for curing times.

Final testing post installation

ThermoSphere Ultimate cables must be properly tested after installing, as well as once the floor finish has been applied. This ensures no damage has been done prior to or during the installation.

Heating cable resistance test



Get your test meter, turn it on and set to ohms and measure the resistance.

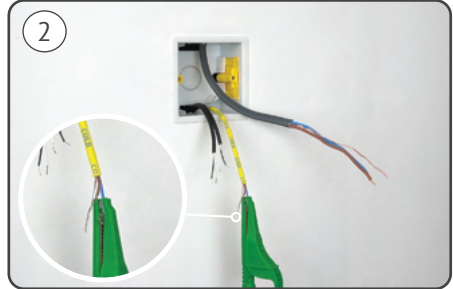

Connect the underfloor heating cold tail neutral (blue) wire to one meter clip.

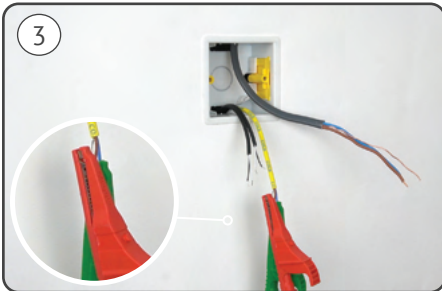

Connect the underfloor heating cold tail live (brown) wire to the other meter clip.



Check your meter reading. It should be within +10/-5% tolerance of the values found on the product label.



Note the results in the customer handover document found on page 30.



All electrical testing and connections should be done by a skilled, professional electrician.

Heating cable insulation resistance test



Set your test meter to Mega Ohms 500V.

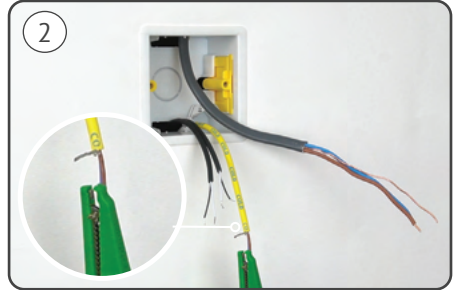

Connect the underfloor heating cold tail neutral (blue) and live (brown) wires to one meter clip.

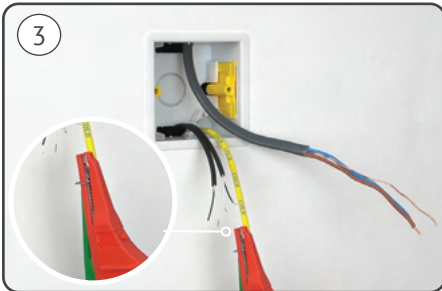

Connect the underfloor heating cold tail earth wire to the other meter clip.



Press test on the meter. Readings over 499 MΩ are considered a pass. (Reading range may differ depending on the meter used)



Note the results in the customer handover document found on pg.30.



All electrical testing and connections should be done by a skilled, professional electrician.

Floor sensor resistance test



Turn on your test meter and set it to ohms.

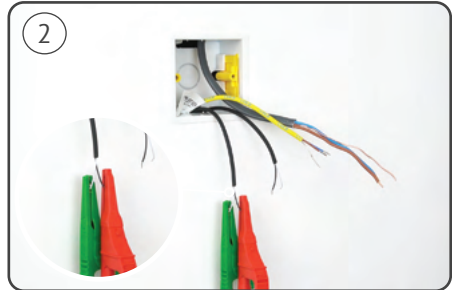

Connect one floor sensor cable to each clip. The cables have no polarity.



The resistance value should be close to the values in the table below, for the ambient temperature.



Record both sensors' resistance result on page 30 of this guide.

Temperature °C	Resistance kΩ
0°C	32
5°C	25
10°C	20
15°C	16
20°C	12
25°C	10
30°C	8

(Floor sensor resistance values table)

Watch how to wire



your thermostat

Wiring your underfloor heating thermostat

The next steps show how to wire a BT21 thermostat. Make sure to check your specific thermostat's instructions as wiring varies between models.



To ensure your safety and to protect the thermostat, safely isolate the circuit from mains power before carrying out any electrical work.

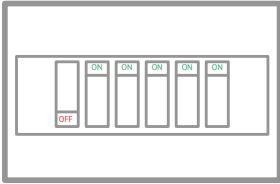

Fuse Box

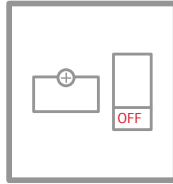

Fused Switch

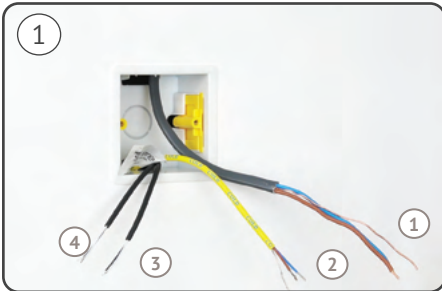
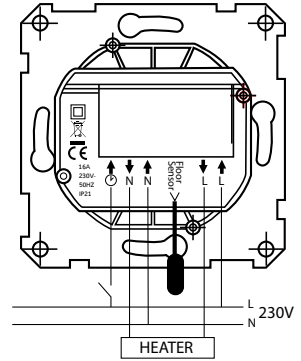

You should have 4 cables at your wiring point. 1. 230V supply 2. Heating cold tail 3. Floor sensor 4. Spare Sensor

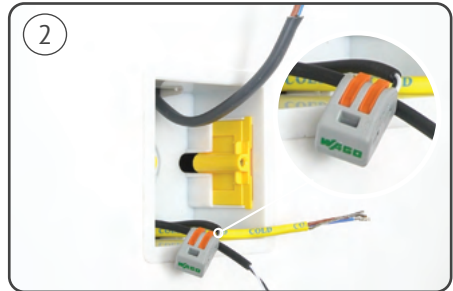

Terminate the spare floor sensor with a terminal block and tuck into the back box.

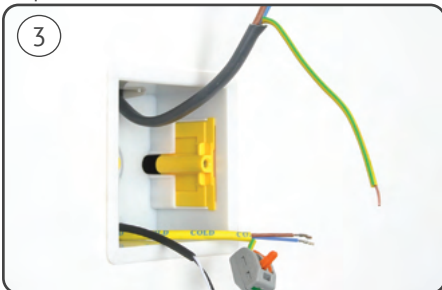

Insulate the supply and cold tail earths with earth sheath.

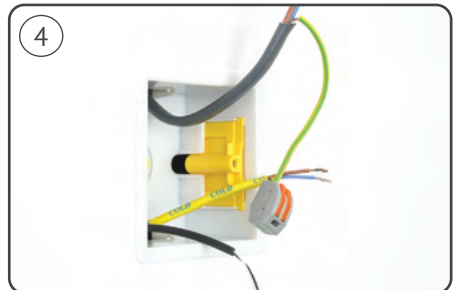

Connect them with a terminal block or into the back box terminal

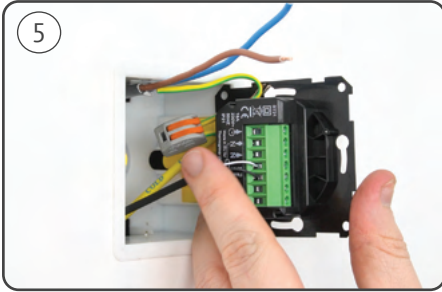

5 Connect the floor sensor to the labelled terminals. The sensor has no polarity.

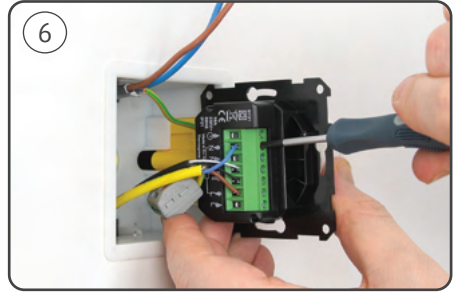

6 Connect the underfloor heating live and neutral to the correct output terminals.

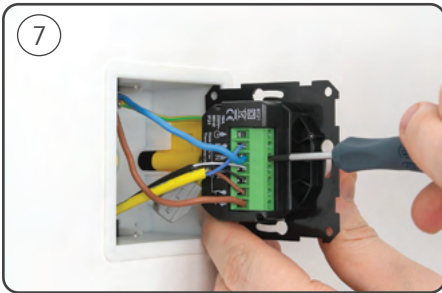

7 Connect the supply live and neutral to the input terminals.

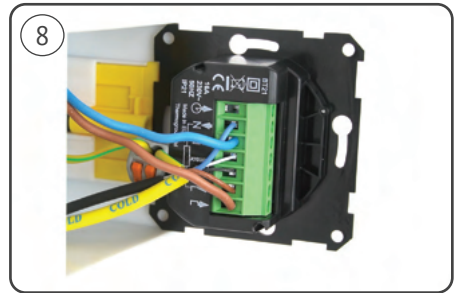

8 Make sure you have a good connection in all terminals and no copper wiring is exposed.



9 Fit the thermostat to the back box with the supplied screws

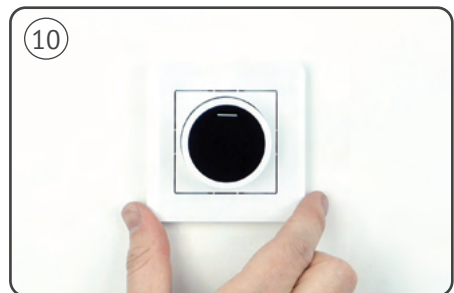

10 Add the thermostat fascia. Final electrical connections must be carried out by a skilled, professional electrician!

Commissioning your underfloor heating

Now you've installed your ThermoSphere Ultimate® underfloor heating system it's important to follow the next few steps to ensure your floors adjust to the heat gradually, and avoid thermal shock.

- 1 Wait until the self levelling compound or tile adhesive is fully cured before switching on your underfloor heating.

Curing usually takes between 7-14 days. Check your manufacturer's guidelines.
- 2 Turn on the electrical power. Ensure heating is off by setting a low temperature eg:5°C.
- 3 Set thermostat to floor sensing.
- 4 Set your floor sensor limit to 27°C.
- 5 Turn the temperature to 2°C over measured floor temperature e.g: if floor temperature is showing 16°C, increase set temperature to 18°C.
- 6 Leave for the first 24 hours and let the floor reach and maintain that temperature.
- 7 Increase the temperature on your thermostat by a maximum of 2°C every 24 hours, until you've reached your desired floor temperature. **Note: max 27°C.**
- 8 You can now switch your thermostat to ambient temperature setting (with floor limit) to maintain room temperature.

How to set up



your thermostat

Test results record and customer handover

Installer: The installer must complete the full test procedure and complete this page in full before giving it back to the home owner to keep in case of a warranty claim.

Homeowner: Use this information to register your Lifetime Warranty at www.thermosphere.com. You must keep this document and proof of purchase for your records in case of a warranty claim.

Stock No	Manufacturer's Values	Before installation	After cable installation	After tile installation
Resistance measurement of the electric heating cable				
Insulation resistance test (two conductors and earth braid)				
	Greater than 499 MΩ			
Floor temperature sensor test				

Installer details	
Name:	Address:
Company:	Postcode:
Email:	Part P number:
Phone:	Date & Signature:

Warranty terms and conditions

Thermogroup Ltd (T/A ThermoSphere) will repair or, if necessary, at its sole discretion, replace a faulty cable, which falls within the Warranty Periods and Territory specified below, subject to the warranty conditions and the warranty exclusions. Warranty Period within the United Kingdom is 25 years from the date of purchase by the consumer as defined by the Competition and Consumer Act 2010. ThermoSphere Heating Cables are covered by a Lifetime Warranty when the installation is registered online with ThermoSphere and a Lifetime Warranty Confirmation has been sent, in writing, by ThermoSphere.

Our goods come with guarantees that cannot be excluded under the UK Consumer Law. You are entitled to a replacement or refund for a major failure that occurs because of a manufacturing fault or manufacturing defect. It is the responsibility of the end user to provide proof of purchase within the Territory, to initiate a warranty claim.

WARRANTY CONDITIONS

This warranty is applicable only for ThermoSphere Decoupling Membrane and Heating Cables (herein referred to as "The heating system").

The heating system must be installed in accordance with the ThermoSphere Installation Instructions, to be supplied with the heating system and/or available as a digital download, and in accordance with all relevant statutory and local regulations of the Territory in which the heating system is installed.

Where a failed component or heating system is replaced under warranty, the balance of the original warranty period will remain effective. The replaced part or heating does not carry a new warranty.

Where a failed component is replaced or repaired under warranty, ThermoSphere will incur costs associated with shipping and repair at its sole discretion, if the unit is installed within the UK. If the unit is outside the UK, the associated costs are the responsibility of the owner.

Where the heating system is installed in a position that does not allow safe, ready access, the cost of accessing the site safely, including the cost of additional materials handling and/or safety equipment, shall be the owner's responsibility.

The warranty only applies to the heating cable and membrane only and, therefore, does not cover any electrical or flooring parts supplied by others that are not an integral part of the ThermoSphere heating system, for example but not limited to; tile adhesive, floor coverings, electrical accessories, thermostats and contactors.

The benefits of this warranty are in addition to other rights and remedies of the consumer under laws in relation to the goods and services to which the warranty relates.

PROCEDURE FOR HONOURING WARRANTY

To initiate a claim for a warranty against defects, the consumer shall contact: Thermogroup Ltd T/A ThermoSphere, Bridge House, Pattenden Lane, Marden, Kent, TN12 9QJ, United Kingdom. hello@thermosphere.com. 0800 0195899.

The process will then follow the ThermoSphere Product Warranty Flow Chart to assess whether the product is under warranty.

WARRANTY EXCLUSIONS

Repair and replacement work will be carried out as set out in the ThermoSphere warranty. However, the following exclusions may cause the ThermoSphere warranty to become void and may incur a service charge and/or cost of parts:

Accidental damage to the heating system or any component, including: Acts of God; failure due to misuse, abuse, fire or flood damage; incorrect installation; damage as the result of transportation, removal or storage; attempts to repair the heating system other than by a ThermoSphere Accredited Service Agent, the ThermoSphere Service Department or a repairer not approved by ThermoSphere.

Where it is found there is nothing wrong with the heating system; where the complaint is related to circumstances where there is no power supply due to faulty electrics; where faults are related to the electrical supply or incorrect installation and not the heating system or heating system components; where there is a failure of electricity supply; where the supply of electricity does not comply with relevant standards, codes or acts, ThermoSphere may then charge the consumer a nominal service charge if inspection reveals no fault with the heating system.

Where the heating system or heating system component has failed directly or indirectly as a result of incorrect cable installation, overheating due to incorrect cable placement, incorrect treatment of the cold tail joint or end termination, failure to encase the entire heated section of the cable as well as the cold tail connection and element in a full bed of tile adhesive or levelling compound, insulating the heating cables from above with permanent fixtures, sanitary ware, furniture or carpets/rugs.

Where the heating system is installed and/or located in a position or fashion that does not comply with the ThermoSphere Installation Instructions or relevant statutory requirements, causing the need for major dismantling or removal of cupboards, doors or walls, or use of special equipment to repair the heating system.

Subject to any rights you have under UK Consumer Law or other statutory provisions to the contrary, this warranty excludes any and all claims for damage to floors, furniture, carpets, walls, foundations, building fabric, possessions or any other consequential loss either directly or indirectly due to damage from the heating system, workmanship or other.

ThermoSphere
Bridge House
Pattenden Lane
Marden
Kent
TN12 9QJ
UNITED KINGDOM

www.thermosphere.com
enquiries@thermosphere.com
+44 (0) 800 019 5899



Find us on LinkedIn
Search "ThermoSphere"



Check out our Youtube channel
Search "ThermoSphere underfloor heating"



Find us on Instagram
Search "ThermoSphere"

All content © 2024 Thermogroup Ltd. ThermoSphere is a trading name of Thermogroup Ltd. E&OE